

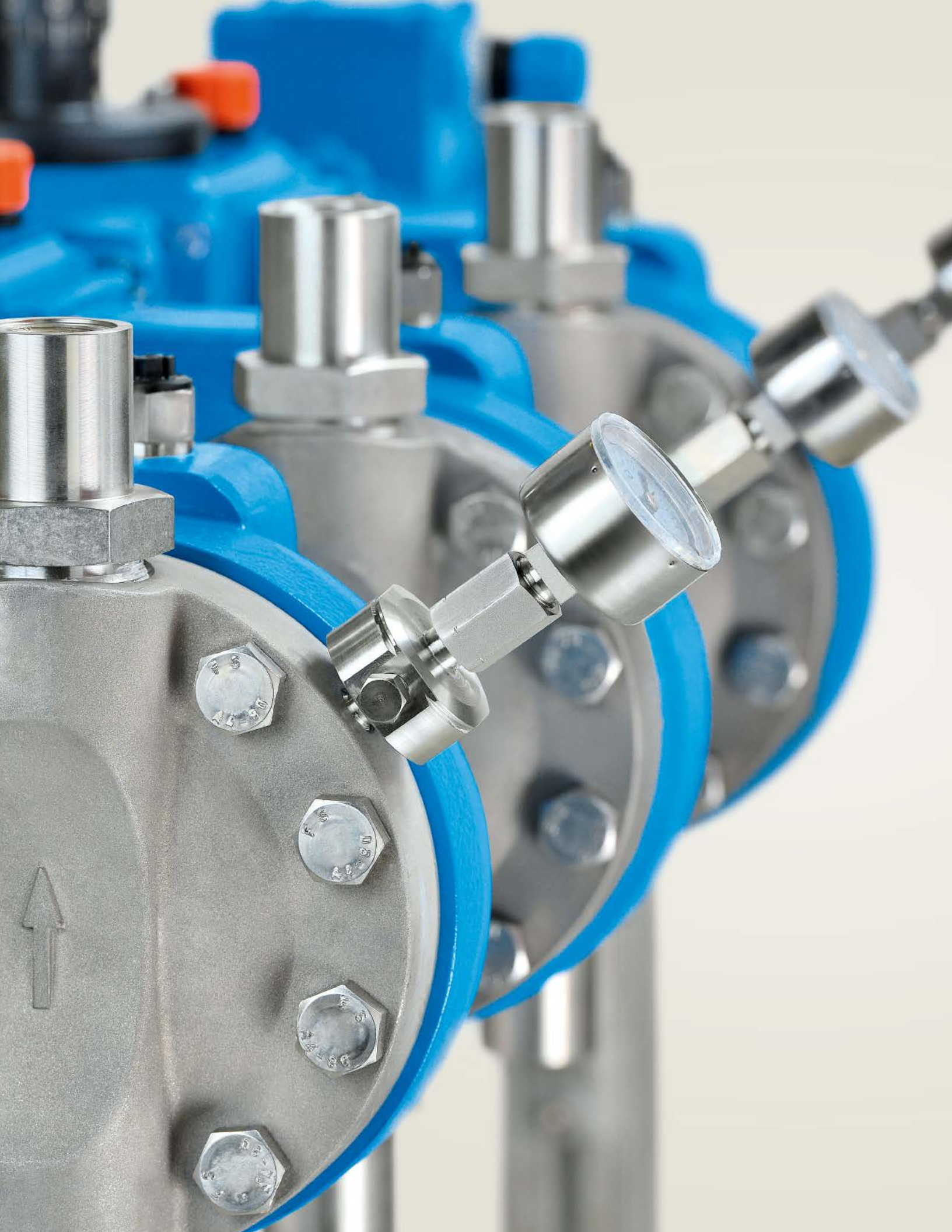

LEWA ecosmart®

The smart and efficient choice for
diaphragm metering pumps







The LEWA ecosmart diaphragm metering pump offers the best value/performance ratio in its class, and meters often costly fluids with high precision. As a positive displacement pump, it operates extremely efficiently.

The LEWA ecosmart's low investment and operating costs as well as its long service life and its robustness make it a winning choice. What's more, no other metering pump in this class offers the same compact dimensions – after all, every inch of space saved in the design and construction of a system leads to a reduction in costs.

LEWA ecosmart: the innovative, compact, and multiplex-capable diaphragm metering pump, featuring proven quality.

LEWA ecosmart – The advantages at a glance

1



Metering accuracy

Careful, precise conveying with outstanding reproducibility. An accuracy level of at least +/- 1% is achieved at constant basic conditions.

2

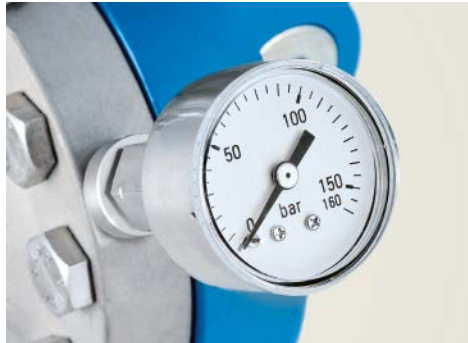

Operational safety and reliability

The pump can be started up with complete reliability from any operating state. We use a PTFE sandwich diaphragm with status monitoring as standard. An integrated hydraulic pressure relief valve prevents the pump from entering potential overload situations.

3



Hermetically tight

LEWA diaphragm pumps work without dynamic seals, due to their design. This permits a hermetically tight working area. There are no emissions to the outside.

4



State-of-the-art technology

The LEWA ecosmart has been developed with state-of-the-art LEWA technology, such as the DPS diaphragm protection system, which automatically positions the diaphragm correctly. The pump also features unrivaled suction capacity.

5



Cost-effectiveness

LEWA ecosmart pumps are very competitively priced. Their low lifecycle costs are based on extremely low failure-related costs as well as low energy costs. Long service intervals guarantee high cost effectiveness.

6

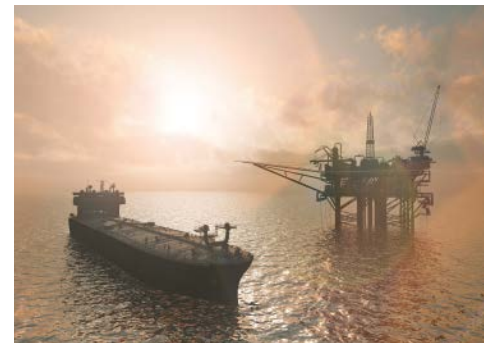

Worldwide service

LEWA is globally organized. Spare parts and service are quickly available worldwide.

Compact design

Standard drives according to IEC and NEMA



LEWA ecosmart pumps are suitable for ATEX zone 1 and zone 2.

Simple installation and commissioning

Maximum metering accuracy

Sandwich diaphragm design with diaphragm monitoring

Meets API 675

Maximum operational reliability

Suction pressure up to 1.5 psig abs.

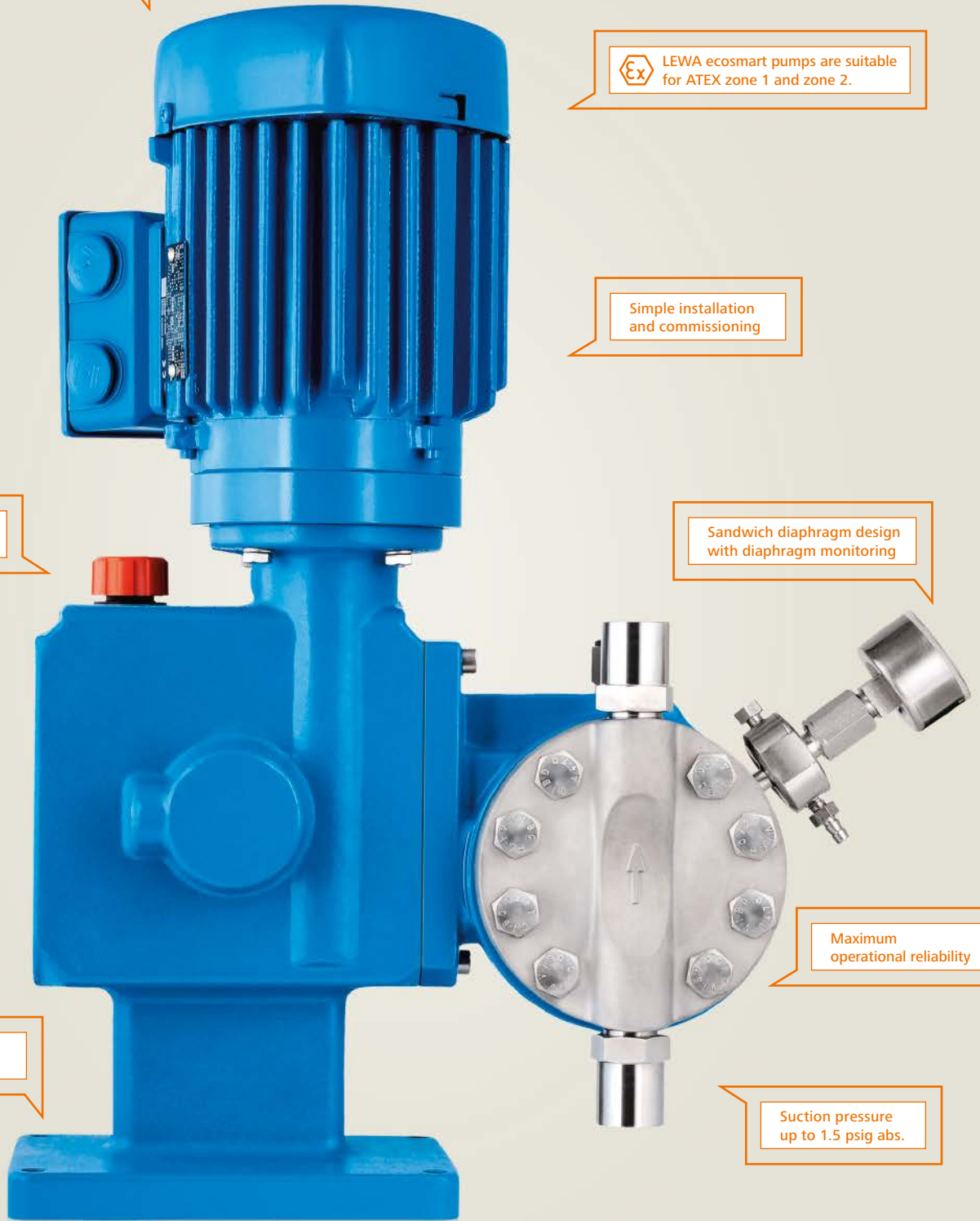

Areas of application

LEWA ecosmart pumps meet even the most stringent requirements in a whole range of application areas. Their conveying and metering features are safe, efficient, precise, and reliable regardless of the tasks and industries.



Chemical metering in industrial
and municipal water treatment systems



Water and fuel conditioning in power plants



pH value correction in industrial and drinking water



Dosing of colorings and flavorings in the food industry



Injection of chemicals in the oil and gas industry



Metering solvents in
the chemical industry

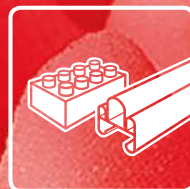

Metering additives in
the plastics processing industry

For a wide variety of requirements. The LEWA ecosmart pump heads.

M900 pump head series for fluids of any kind.

Innovative, state-of-the-art diaphragm pump head series for maximum operational reliability and safety. The patented LEWA Diaphragm Protection System (DPS) technology also enables a suction capacity that is unrivaled by any other solution worldwide in the field of hydraulically actuated diaphragm pumps.



M910

M910 in stainless steel design with PTFE sandwich diaphragm.



M930

M930 in PVC design with PTFE sandwich diaphragm.

For fluids of any kind.

The diaphragm pump head with cutting-edge technology.

The M900 pump head is an innovative, state-of-the-art diaphragm pump head with a PTFE sandwich diaphragm for maximum operational reliability.

It features large safety reserves, especially during the startup. The patented LEWA DPS technology also enables a suction capacity that is globally unique in the field of hydraulically actuated diaphragm pumps.

Technical data

| | |
|--------------------|-------------------------------|
| Discharge pressure | up to 1,160 psig |
| Flow rate | up to 79.25 gph per pump head |
| Temperature | from +5.0 to +248.0°F |
| Viscosity | up to 100,000 mPa·s |
| Design | Stainless steel and PVC |

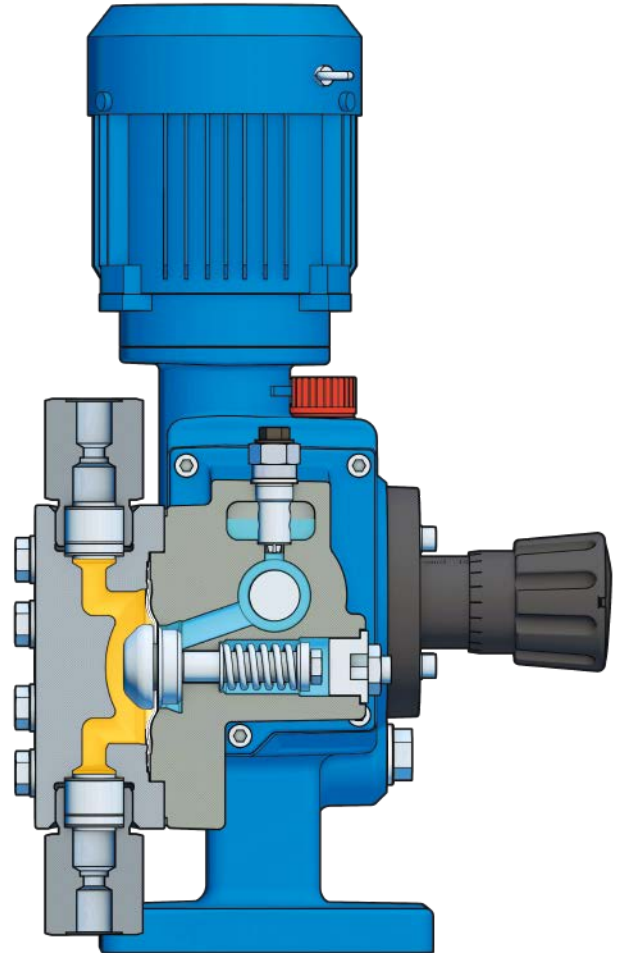

Outstanding advantages

Globally unique suction lift capability

Suitable for vacuum extraction

Simple, reliable start-up, even under extreme conditions

Patented DPS diaphragm protection system

Very low maintenance costs and long service intervals

Suitable for slurry applications

Dry run safe

Integrated hydraulic pressure relief valve

Robust technology and proven quality

Reliable components are one of the keys to safe processes.

LEWA ecosmart pumps are based on the robust technology that LEWA is renowned for. As a result, they are also easily able to fulfill the strict safety requirements of API 675 (American Petroleum Institute). The pumps use key components from LEWA's proven range – like the PTFE sandwich diaphragm with diaphragm monitoring, the patented DPS diaphragm protection system and flow efficient check valves.



DPS diaphragm protection system

Diaphragm pumps are used when leak tightness and operational reliability are in demand. Especially for hazardous, abrasive, environmentally harmful, or sensitive fluids. The diaphragm is hydraulically actuated to ensure a balanced load. In combination with the DPS (Diaphragm Protection System) a long diaphragm service life, maximum operational reliability and an unrivaled suction capacity are ensured.



Diaphragm monitoring

Any diaphragm damage is displayed reliably by the diaphragm monitoring feature. The safety sandwich construction allows the pump to keep running without any problems until the next planned shutdown. Diaphragms can be replaced very easily when required.



Flow efficient check valves

Operational reliability and failure risk are critically dependent on check valve quality. The valve design is therefore adapted to the specific application.

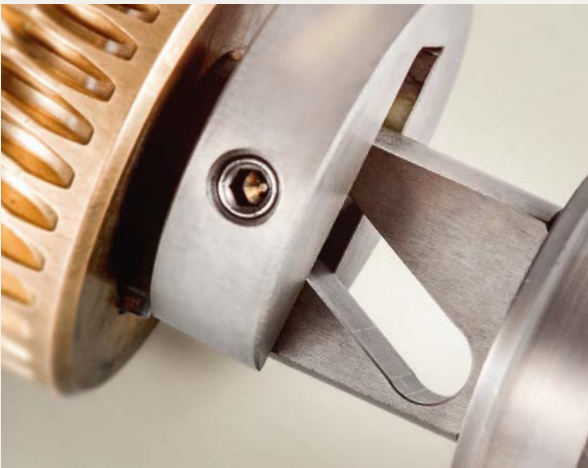

Variable eccentric principle for flow adjustment

For the liquid flow adjustment, LEWA uses its proven variable eccentric principle; this also enables easy operation. The stroke length is adjusted directly on the eccentric shaft. The handwheel can be used to make a linear stroke adjustment in 0.0020 inch increments, either during standstill or operation. The pistons move in harmony even in the partial stroke range, preventing additional, disruptive pulsations in this range. The solid dimensioning and high-quality materials, oil bath lubrication, and protection against weather and splash water ensure a long service life. Maintenance work is extremely easy to perform. The equipment is driven using motors. In multiplex versions, a range of drive unit stroke frequencies enables adjustment in line with different fluids and other basic conditions.



Stroke adjustment

The drive units are equipped with manual stroke length adjustment as standard. As an option, it is also possible to equip the LEWA ecosmart with an electrical actuator for stroke length adjustment.

Options

Individual configurations are available on request, such as painting for seawater applications, material test certificates, and acceptance in accordance with API (American Petroleum Institute) criteria.

Customized valves

Diverse connection geometries

PVC wetted parts

Integration into process control systems via analog and digital signals, using a frequency inverter or electrical stroke adjustment.

Features and advantages of electrical stroke adjustment:

- Power supply with large voltage range of 90 to 264 VAC (single-phase)
 - Servomotor technology for high precision
 - Manual operation (handwheel does not move during automatic operation)
 - Analog input signals 0-10V; 0/4-20 mA or fieldbus
 - Integrated active feedback signal 0-10V; 0/4-20 mA
-

Explosion protection

Multiplex capability

- As single drive unit with space-saving vertically installed motor
 - Multiple drive units that can be combined with identical or different output, for higher output, pulsation reduction or recipe metering, for example
-

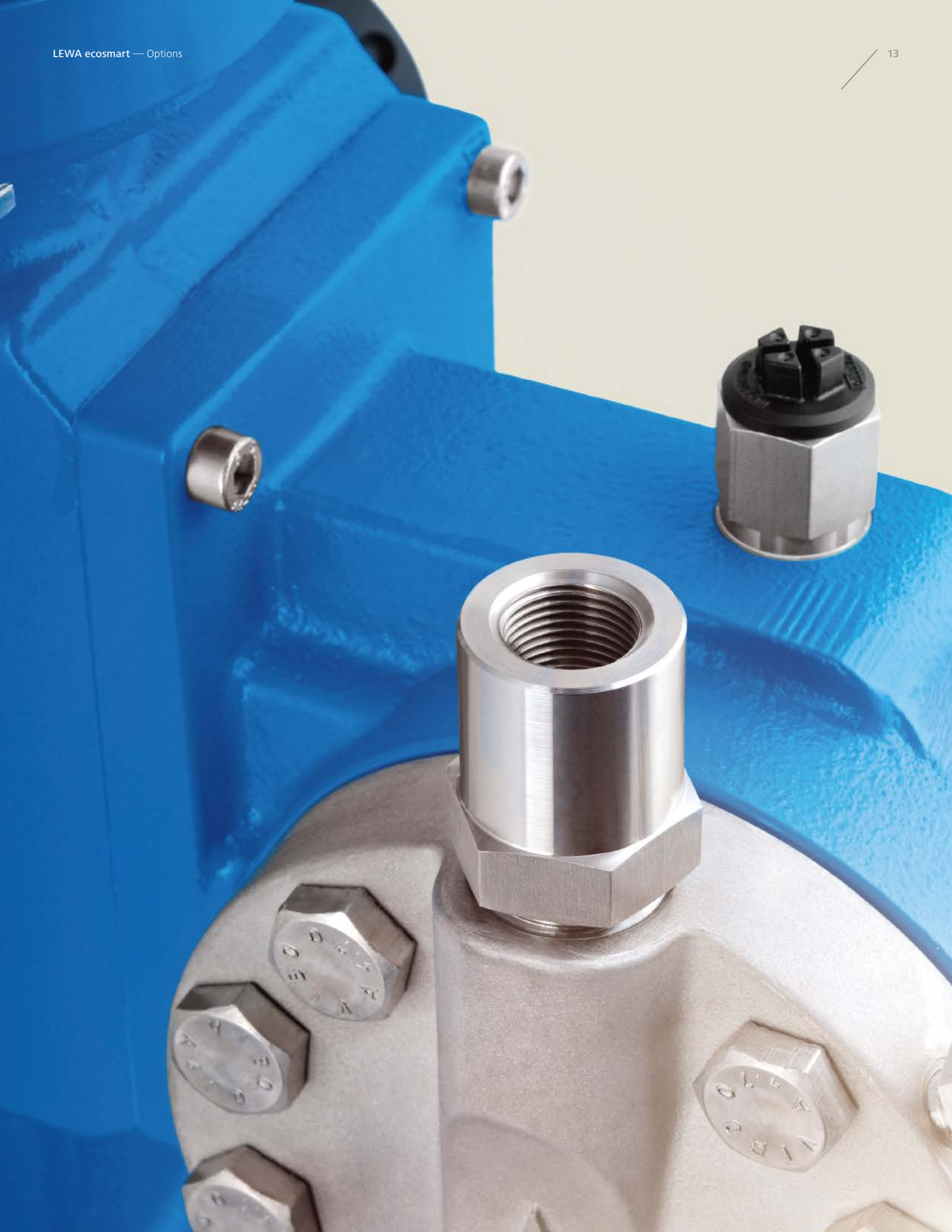

At a glance.

Technical data.

Performance overview to determine stroke frequency and pump head size

| Type | Piston \varnothing [inch] | Q_{theor} [gph] for each pump head, at full stroke length and stroke frequency | | | | | p_{max} discharge pressure [psig] 316L | p_{max} discharge pressure [psig] PVC |
|------|-----------------------------------|---|------|------|------|------|--|---|
| | | n = | | | | | | |
| | | 102 | 138 | 173 | 208 | 277 | | |
| 1 | 0.24 | 0.7 | 0.9 | 1.2 | 1.4 | 1.9 | 1,160 | 174 |
| | 0.31 | 1.2 | 1.7 | 2.1 | 2.5 | 3.3 | 1,160 | 174 |
| | 0.43 | 2.3 | 3.1 | 3.9 | 4.7 | 6.3 | 1,160 | 174 |
| 2 | 0.55 | 3.7 | 5.1 | 6.3 | 7.6 | 10.2 | 1,160 | 174 |
| | 0.67 | 5.5 | 7.5 | 9.3 | 11.2 | 15.0 | 812 | 174 |
| 3 | 0.87 | 9.2 | 12.5 | 15.7 | 18.8 | 25.1 | 479 | 174 |
| | 1.10 | 15.0 | 20.2 | 25.4 | 30.5 | 40.6 | 276 | 174 |
| 4 | 1.38 | 23.4 | 31.6 | 39.6 | 47.6 | 63.5 | 174 | 145 |
| | 1.65 | 33.6 | 45.5 | 57.1 | 68.6 | 91.4 | 102 | 102 |

Pump heads

| Type | Discharge pressure | Flow rate | Temperature | Viscosity * | Material |
|------|--------------------|-----------|---------------|---------------|----------|
| M910 | 1,160 psig | 79.25 gph | +5.0/+248.0°F | 100,000 mPa·s | 316L |
| M930 | 174 psig | 79.25 gph | +5.0/+140.0°F | 100,000 mPa·s | PVC |

* Requires sufficient suction pressure

Assembly dimensions, single pump

| Type | Piston \varnothing [inch] | L [inch] | W [inch] | H _{0.18 kW} [inch] | H _{0.37 kW} [inch] | H _{0.55 kW} [inch] |
|------|--------------------------------|-------------|-------------|--------------------------------|--------------------------------|--------------------------------|
| 1 | 0.24 - 0.43 | 8.66 | 11.22 | 17.17 | 17.95 | 20.75 |
| 2 | 0.55 - 0.67 | 9.06 | 11.81 | 17.17 | 17.95 | 20.75 |
| 3 | 0.87 - 1.10 | 10.63 | 12.01 | 17.17 | 17.95 | 20.75 |
| 4 | 1.38 - 1.65 | 11.22 | 13.39 | 17.17 | 17.95 | 20.75 |

The H values relate to the standard motors used by LEWA.

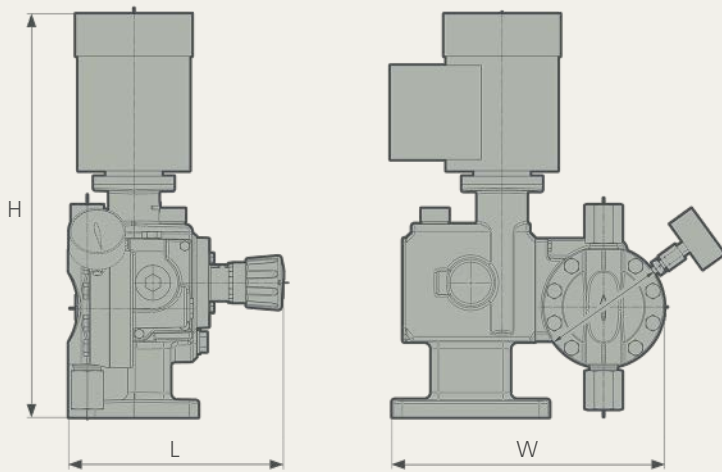

Multiplex pump assembly dimensions [inch]

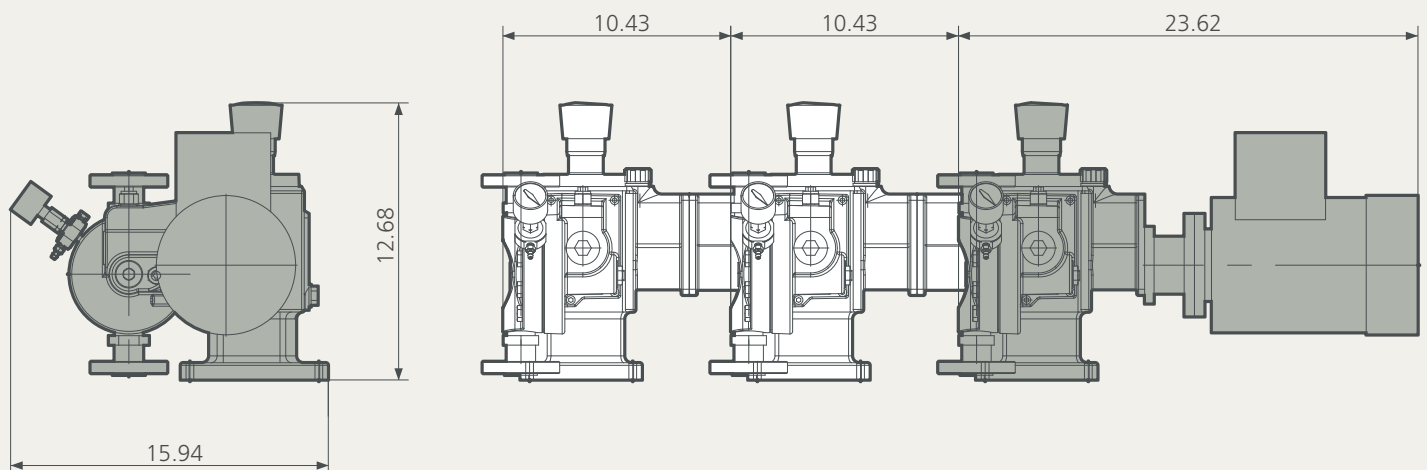

Creating Fluid Solutions. For more value created.



Technical consulting

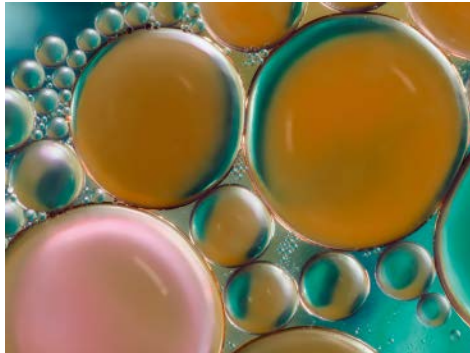

Fluid and process engineering tests



Lifecycle concepts and energy optimization

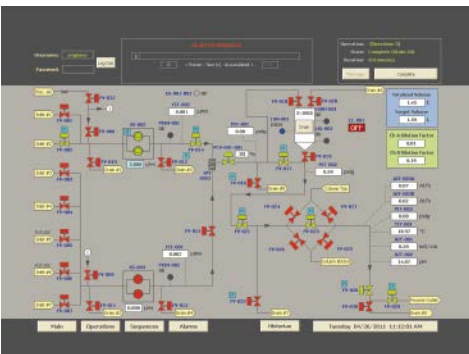

Process automation

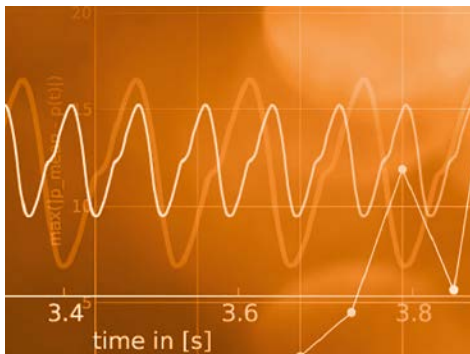

Pulsation studies and pipeline calculations



System layout and integration



Creative development and refinements



Commissioning and maintenance service



Spare part and service concepts

Creating Fluid Solutions.

Driven by our commitment, our trendsetting products and innovative technologies have set benchmarks for diaphragm pumps and metering systems for over 70 years. We solve complex tasks from a single source that ranges from custom pump design, basic and system engineering, global project management, and pre-testing to commissioning and maintenance on site. Our consistent drive is to always develop the best solutions for the customer, provide a competitive advantage and visible added value.

LEWA-Nikkiso America, Inc.

132 Hopping Brook Road
Holliston, MA 01746, USA
Phone: +1 508 429-7403
Fax: +1 508 429-8615

LEWA-Nikkiso America, Inc.

Gulf Coast Sales & Service Center
2446 Greens Road
Houston, TX 77032, USA
Phone: +1 713 577-5392
Fax: +1 713 577-5393

sales@lewa-inc.com
www.lewa-inc.com

Your local representative:

