

LEWA Odorizing systems

For natural gas, biogas and liquefied petroleum gas.



Contents

03	Advantages at a glance
04	Principle
06	Custom-made solutions and optimum execution
08	Odorizing systems
12	Essential components
14	References
16	Equipment and options
18	Life time services
20	Technical data



For decades, customers from all over the world have placed their trust in LEWA systems for odorizing gas. Our portfolio ranges from systems for micro flow metering, such as biogas plants, to gas pressure regulating stations. This process always entails quantity-based odorization regulated by the gas flow.

We supply ready-to-connect odorizing systems tailored both to your specifications and exactly to your needs. The modular design of each odorizing system makes it exceptionally economical. In addition, they work with absolute precision and reliability. The systems are used for odorizing various gases such as LPG and CNG, as well as for feeding liquefied natural gas into a distribution network. They are also used to odorize oxygen and industrial gases.



LEWA odorizing systems.

The advantages at a glance.

1



Safe

We use only tried and tested control and regulating systems for smooth operation. LEWA controllers are compatible with all proven flow meters and can also be provided in explosion-proof housing.

2



Economical

The flexibility of our systems makes it possible to provide reliable, precise and cost-saving dosing of all common odorants such as THT, mercaptan, sulfur-free odorants or any kind of mixtures.

3



Flexible

LEWA odorizing systems can be used for a wide variety of gases, such as natural gas, LPG, CNG, biogas, and technical gases.

4

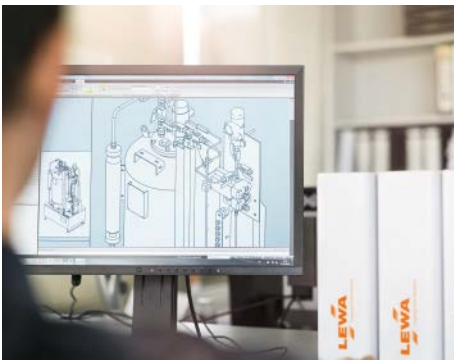

Custom-made solutions

We work with you to find the right solution for every requirement. We manufacture customer-specific systems, with standard modules or even with special components. All components are perfectly optimized and synchronized with one another.

5



Hermetically tight

LEWA diaphragm pumps work without dynamic seals due to their design. This permits a hermetically tight working area. There are no external emissions and contamination of the fluid is impossible. This allows us to guarantee an exact and reliable dosage of odorant.

6



Worldwide service

LEWA is a global company. Whether maintenance, spare parts or repair, our trained service technicians are available worldwide. Thus, we guarantee fast response and smooth operations.

The principle of LEWA odorizing systems.

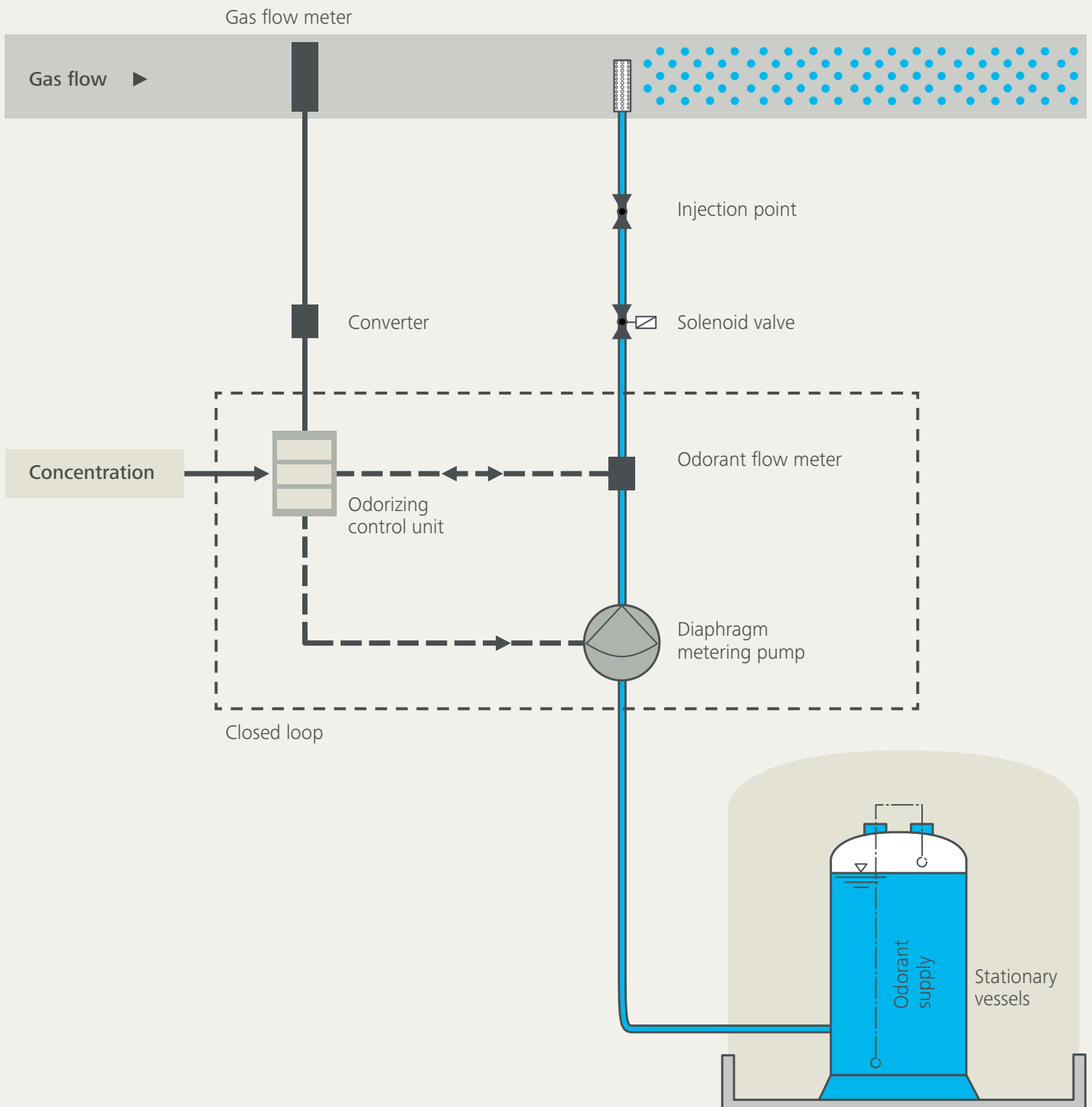

Odorizing diverse gases

Customized use to match the application

LEWA offers standard odorizing systems as well as customized systems for odorizing a large variety of gases and gas mixtures:

- Natural gas (methane)
- Liquefied petroleum gas (LPG, propane, butane)
- Biogas, industrial gases (gas mixtures)
- Oxygen, nitrogen, and others



Fields of application: Gas pressure control systems, refinery

Application: Natural gas, LPG

LEWA solution:

System with stationary vessels for long periods of operation between fillings

Features: A pump, a tank, drip pan, activated carbon filter



Custom-made solutions and optimum execution.

Project management

Consultation

- Individual discussion of the customer's needs
- Presentation of options and recommendations

Proposal

- Customized preparation of every offer
- Basic offer with potential options

Engineering

- Customized design of each project
- Conforms to all national and international regulations

In-house production

- Ongoing quality assurance
- Lean production

Flexible storage tank design

We offer systems for stationary and exchangeable vessels in sizes from 7 up to 1,000 liters, and upon customer request also large-scale systems of up to 10,000 liters.

Visible filling monitoring

The optical level indicator can also be used for calibration. Odorant level indicators and overfilling protection in accordance with TRbF are an intrinsic part of systems with a stationary vessel.

Leak-proof

All drip trays comply with the regulations for stationary systems for the storage of water-polluting materials and are leak-proof as well as WHG and VAWS-compliant, including all necessary certificates.

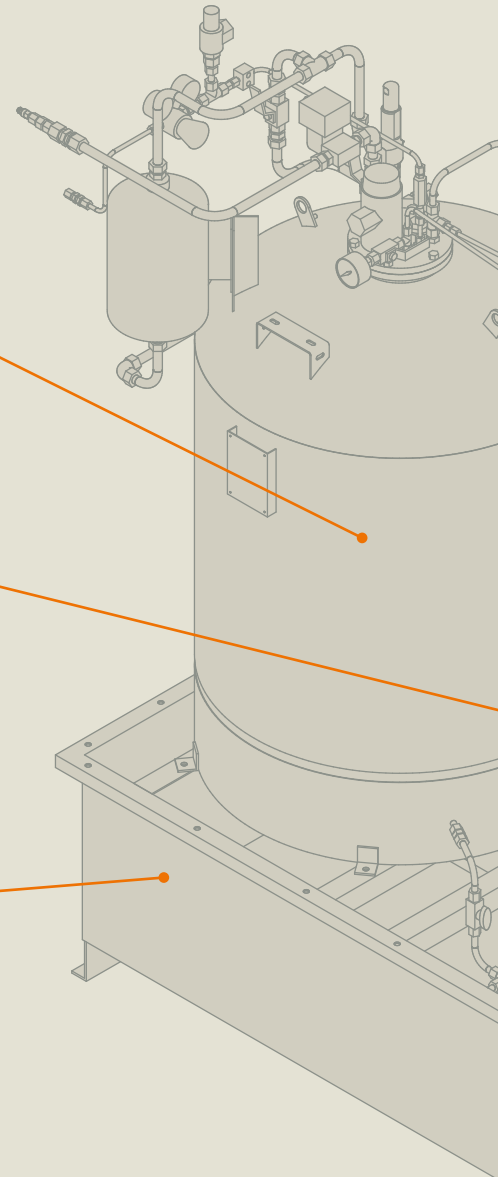

Testing, acceptance and inspection

- Internal acceptance tests
- Customized tests according to customer specifications

Delivery and commissioning

- Worldwide service network
- Technical service at every location, in accordance with uniform quality standards

After sales service

- Skilled and certified employees
- Original LEWA spare parts
- Maintenance activities

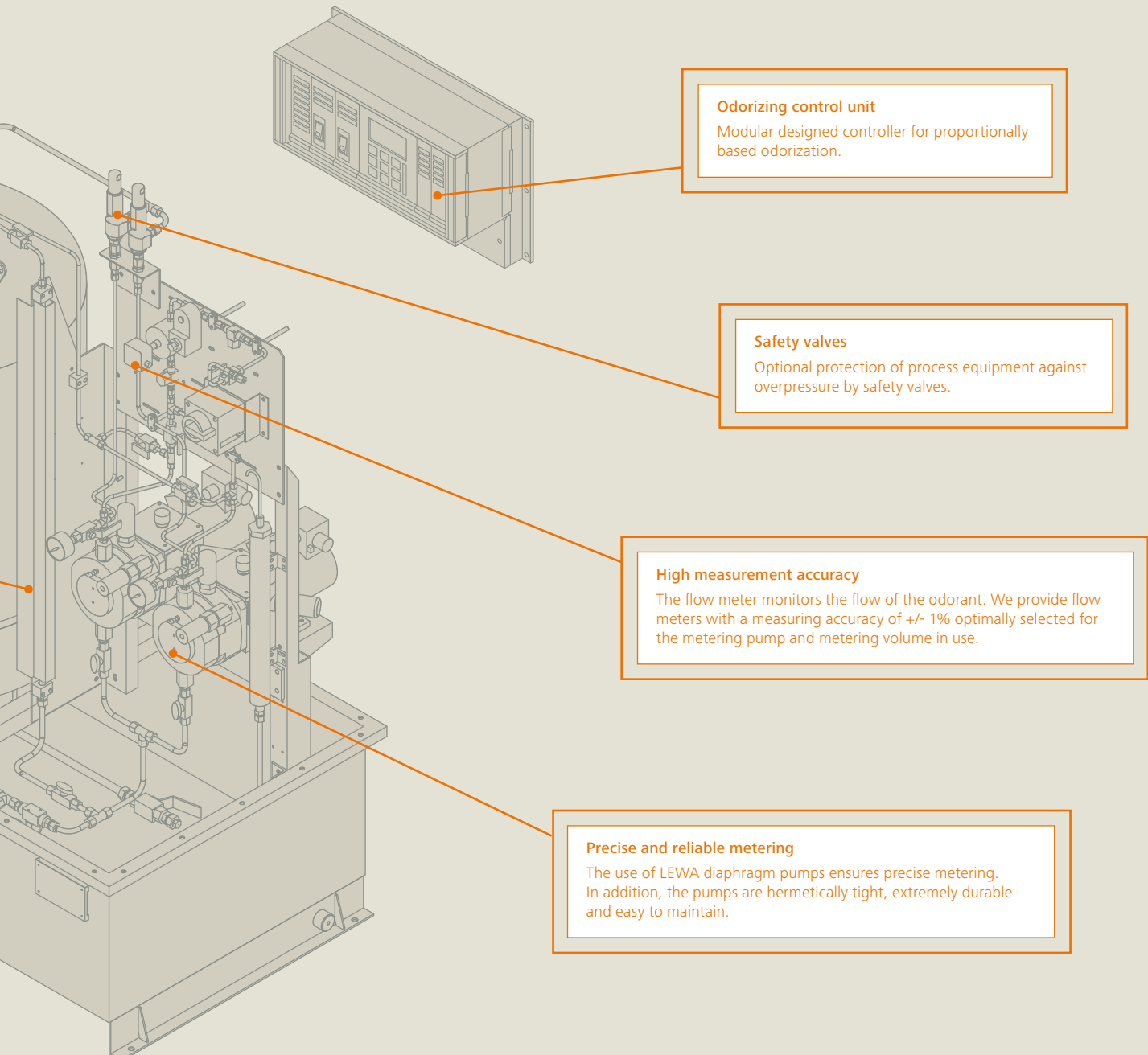



For reference data, see page 14.

For customer-specific requirements. Customized odorizing systems.

Customized odorizing systems from LEWA come from a single source. All components are precisely synchronized to one another and ensure a high level of availability and operating reliability.

LEWA designs, builds and delivers the perfect solution for your odorizing application. A design that is cost-effective and technically optimized is always our number one priority. Individual on-site operating data and conditions are also taken into account. The solutions comply with legal requirements and standards. We take care of all the details. We use the latest technologies to develop the right customer-specific odorizing system and guarantee its functionality. As the leading pump manufacturer, we do not compromise on the quality of the components.

Optional features:

Pressure vessel in accordance with ASME VIII Div. 1

Odorant mass flow meter

Odorant leakage detector

Stainless steel cabinet (with heating and insulation)

Offshore surface preparation and painting (for pump and cabinet)

Oxygen gas detectors

Integration into existing plant systems

Ex lighting for the cabinet

Pressure and temperature sensors

For standard applications. Pre-configured odorizing systems.

In addition to completely customized odorizing systems, we also offer pre-configured systems for various standard applications, which contain the same main components and can thus be implemented even more economically. Of course, we can also take into account specific requirements here.



For stationary filling: Systems with permanently installed vessels

Standard systems for special applications:

- Odorizing of oxygen, nitrogen and combustion gases
- Compact system includes metering pump, measuring devices and electronic components
- Optionally designed with lockable stainless steel cabinet

Standard systems with fixed vessels:

- Fixed installed vessels in sizes of 60 l, 120 l, 240 l, 450 l, 1,000 l
 - Vessel filling on-site at the plant from disposable barrels, semi-bulk containers, tank trucks
 - The vessels are shock-resistant to explosion pressure
 - Optionally supplied with nitrogen pressurizing system
-



For interchangeable containers: Plants with interchangeable vessels

Standard OD7 and OD8 systems for interchangeable vessels

- Standardized odorant barrels in 25 l, 50 l, 100 l and 200 l sizes
 - Filling of the barrels by the odorant supplier
 - Barrels can be changed without interruption of odorizing process
 - Several types of barrel connections possible
 - Drip pan as option
 - To be mounted on the wall, on the bracket or on the drip pan
-

The most important components for cost-effectiveness and safety.

LEWA pumps

The pump is the heart of every LEWA odorizing system. We use diaphragm metering pumps from our own production. These provide:

- Continuous adjustment of stroke length and frequency, ensuring an accurate and wide metering range.
- Pressure has no influence on the pumping characteristics, which makes monitoring easy and precise.
- High metering accuracy paired with flow measurement/monitoring ensures reliable and reproducible delivery rate
- Reliability and ease of maintenance

For special metering requirements we also select and provide other types of pumps.

All components are optimally matched to your requirements.



Solenoid-driven pumps

LEWA MAH, MBH and MLM micro-metering pumps

They have an extremely wide control range for maximum metering flexibility as well as very low turn down ratios. Four different solenoid power sizes cover a wide range of applications. The hydraulically actuated metering pumps with metal diaphragm and solenoid drive implement flow rates from 1.0 ml/h up to 55 l/h and pressures up to 560 bar.



Motor-driven pumps

LEWA ecoflow diaphragm metering pump

It features an exact metering rate and enormous durability in extreme operating conditions. Low maintenance costs and high energy efficiency complete the profile. The ecoflow series implements a flow rate of up to 19 m³/h per pump head and a discharge pressure of up to 1200 bar, and is certified in accordance with API 675.



Pneumatically driven pumps

LEWA PKH diaphragm metering pump

This is a high-pressure diaphragm metering pump powered by compressed air or gas. It is hermetically tight and diffusion-resistant, making it the pump of choice when there is no electricity available. The pump achieves flow rates of up to 10 l/h and discharge pressures of up to 300 bar.

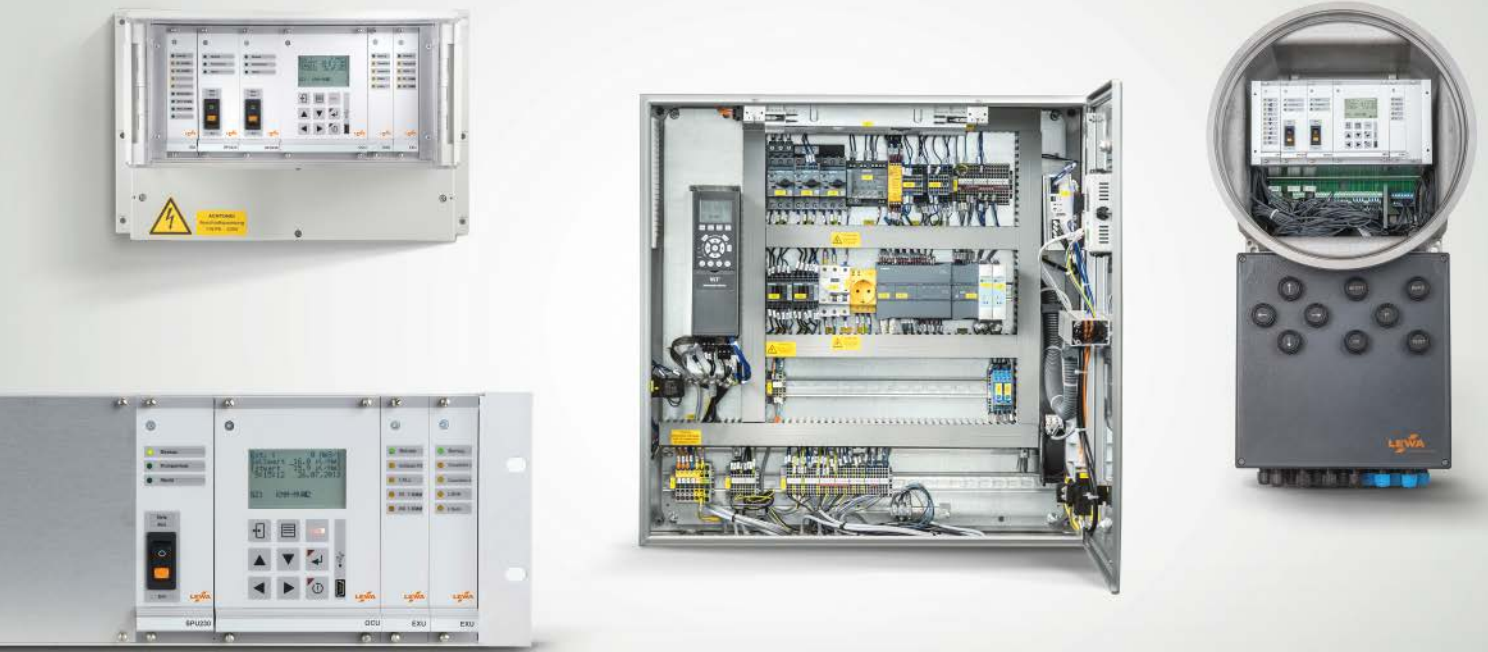

Odorizing control unit

LEWA offers a complete solution for fully automated monitoring and control of odorizing systems, which is also ideal for retrofitting existing LEWA or third-party systems. All important operating data are available in the form of output signals for registration and remote communication.

Fully reliable solution that saves time and cuts costs

- Thanks to continuous monitoring of the odorant flow, the monthly measurements requested by DVGW can be skipped or done less frequently.
- Operator friendly interface
- Setting the odorant concentration is easy and precise. It is carried out in digital steps of $0.1 \mu\text{l}/\text{Nm}^3$ at the controller. A set value/actual value comparison is possible at any time.
- The regulation of the metering rate occurs automatically within the closed loop control. A fault message is issued only when the adjustable tolerance range is exceeded. This avoids the complexity of setting the concentration by adjusting the pump stroke length.

Flow meters

Flow meters measure the volumetric or mass flow rate and transmit the actual value to the controller. The following flow meters are available.



Flow meter	ZHM	KMM, KMM Bio	Coriolis
Pump	MBH/MLM/ecoflow LDB	MAH	MAH/MBH/MLM/ecoflow LDB
Type	Gear type flow meter	Micro flow meter	Mass-flow meter
Features	<ul style="list-style-type: none"> – Detection of flow direction and pulse multiplication – Pressure-resistant housing up to 1000 bar 	<ul style="list-style-type: none"> – Precise measurement and evaluation of the actual odorant flow without additional calibration of the pump metering volume at the control device – Changes in the pump output are detected and, if necessary, automatically regulated by the control device. – If there is no longer any flow due to a failure of the pump or lack of fluid, a fault message is issued. – Due to its unique design, repair and calibration is possible on-site – No under or over-odorization thanks to the exact adjustment and metering of the product with closed loop control 	<ul style="list-style-type: none"> – High flexibility for system integration – Process pressure up to 400 bar – Easy commissioning – No wearing parts

References of customized odorizing systems.

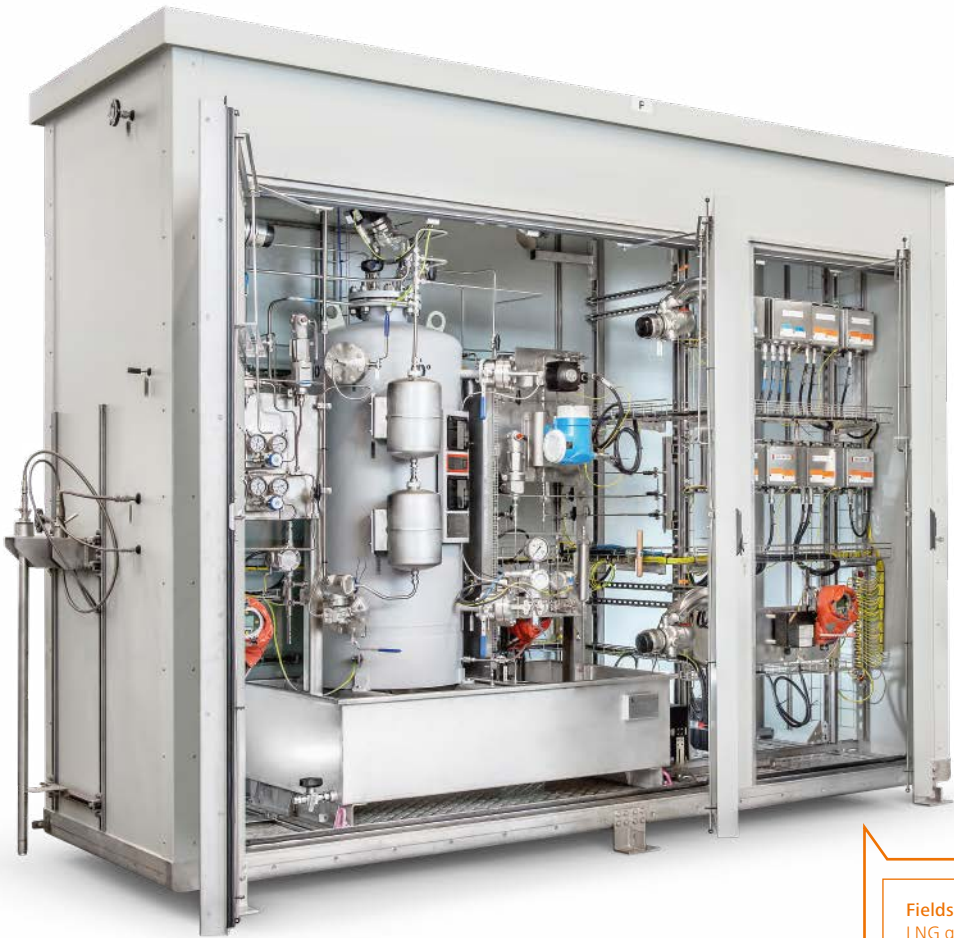

Fields of application:

LNG gas terminal

Installation location:

Yamal Peninsula, Russia

Application: Natural gas

LEWA solution:

Customized odorizing system

Features: Ambient temperature of -50 °C,
fire detection, TR CU and ASME certification



Fields of application:

Natural gas supply

Installation location:

Ochtrup, Germany

Application: Natural gas

LEWA solution:

Customized odorizing system

Features:

Triple system with three vessels and four
LEWA ecoflow pumps (LDB)





Fields of application:
Natural gas supply
Installation location: Hungary
Application: Natural gas
LEWA solution:
LEWA standard odorizing system
Features:
Stainless steel cabinet with heating and insulation



Fields of application:
LPG ship usage
Installation location:
Lyttelton, New Zealand
Application: LPG
LEWA solution: LEWA OD7 odorizing system, seawater-resistant cabinet
Features:
Use of PKH pumps at the work site because no continuous power source is available



Standard equipment and options.

To keep the odorant smell in the odorized gas only, our systems and all related components meet the highest quality requirements, from design phase, through all stages of production to start-up and commissioning on-site.

Standard equipment

Activated carbon filter

- Odorless environment
- Installed in every system for exhaust air purification

Injection points

- Large evaporation area
- Optimal odorant distribution in the gas
- Check valve and two shut-off valves to protect against gas and odorant leakages during maintenance work
- Suitable for all types of gases, such as NG, LNG, LPG, biogas, oxygen
- Suitable for all phases (gaseous, liquid)
- Pressure rating up to 100 bar
- Retractable injection point:
 - simple operation and assembly without depressurizing of the gas pipe
 - Connection G 1"

Solenoid valves

- Protecting the system against backflow

Flushing unit

- Remove the odorant from the pump head and the pipelines before the start of maintenance work
- More efficient work with less odorant smell

Connecting elements

- Pipe connections with double ferrule fitting
- Lasting tightness even after re-assembly
- Hose connections optionally available with dry-break quick release couplings

Drip pan

- Optimally adapted to the system size and design
- Tested and certified with 3.1 certificate
- Tightness approved with dye color penetration test
- In compliance with WHG and Stawa-R standards



Options

Level indicator

- Monitoring and control of odorant level in the stationary vessel in accordance with TRbF/WHG (Technical Regulations for Flammable Liquids/Water Regulation)
- Digital notification of odorant's flow level by level switch
- Optional level transmitter with 4-20 mA output signal

Leakage sensor

- Local odorant leakage sensor
- Simple and structured operating concept
- Optional shutdown of the system after detection of an odorant leakage

Local indicators

- Pressure gauges or transmitters
- Temperature gauges or transmitters

Cabinets

- Stainless steel cabinet in 1.4301 or 316/316L design
- Optionally available with offshore paint
- Optionally available with sunshade

Nitrogen blanketing unit

- Protecting of the vessel with safety valves (setting pressure up to 3.0 bar)
- Protection against outgassing of the odorant in the suction line, especially for odorants with high vapor pressure.

And much more

- Design of the entire system according to customer specifications



Life time services. For continuous operation.

For our first-class odorizing systems, we offer a maintenance and repair service tailored to your needs. The work is carried out only by specially trained technicians.

Your advantages

Maintenance contracts with fixed maintenance intervals for a longer service life, low operating or repair costs and high operating reliability.

Fast service on-site through our worldwide sales network

Service vehicles with all necessary wear and spare parts

Seminars with a real-world focus for training your staff with sound expertise all in one place



LEWA odorizing systems offer the highest quality, as demonstrated by our certifications.



Ex: All LEWA odorizing systems are available in II 2G IIC T4 design for the Ex zone 1.



TÜV: External approval confirmed with certificates.



PED: Project planning and production of the vessel in accordance with the Pressure Equipment Directive.



CE: Certification in accordance with CE (“Conformité Européenne”) marking is standard for European customers; it is also available for non-European customers upon request.



ASME: Certification of the storage vessel available in accordance with ASME.



API: API certificate for LEWA ecoflow diaphragm metering pumps available upon request.



TR-CU and TR-CU-Ex: The pumps are certified for the Eurasian Economic Union (EAEU).



3.1: Optionally, we offer the 3.1 acceptance test certificate for all parts that come into contact with the media.



IECEX: IECEX certificate for pumps available upon request.

At a glance.

Technical data.

Pump data at a glance: Magnetically driven pumps

Piston diameter	Flow rate				Pressure			
	Series	MAH	MBH	MLM 15	MLM 40	MAH	MBH	MLM 15
3 mm	0.175 l/h	—	0.3 l/h	0.3 l/h	20 bar	—	300 bar	560 bar
4 mm	0.25 l/h	—	—	—	16 bar	—	—	—
5 mm	0.5 l/h	—	1 l/h	1 l/h	10 bar	—	80 bar	200 bar
8 mm	1.3 l/h	1.8 l/h	2.8 l/h	2.8 l/h	4 bar	50 bar	30 bar	80 bar
10 mm	—	2.5 l/h	5 l/h	5 l/h	—	40 bar	20 bar	50 bar
12 mm	—	—	7.5 l/h	7.5 l/h	—	—	10 bar	30 bar
16 mm	—	—	—	15 l/h	—	—	—	20 bar
20 mm	—	—	—	—	—	—	—	—

With 24 VDC applications, pressure and quantity are reduced by about 20%.

Pump data at a glance: Motorized pumps

Piston diameter	Flow rate			Pressure			
	Series	LEWA ecoflow LDB	PKH 7 bar service air	PKH 14 bar service air	LEWA ecoflow LDB	PKH 7 bar service air	PKH 14 bar service air
3 mm	—	—	—	—	—	—	—
5 mm	—	—	—	—	—	—	—
8 mm	5 l/h	—	—	350 bar	—	—	—
10 mm	9 l/h	10 l/h	10 l/h	250 bar	150 bar	300 bar	—
12 mm	12.5 l/h	—	—	170 bar	—	—	—
16 mm	25 l/h	—	—	95 bar	—	—	—
20 mm	35 l/h	—	—	60 bar	—	—	—

The data in the tables are reference values.

Determination of the type of system and odorant vessel size for systems with stationary vessels

Stationary vessels	Maximum odorable gas flow [Nm ³ /h] with an odorant concentration of 20 µl/Nm ³							
Vessel sizes [liters]	10,000	12,500	20,000	30,000	70,000	100,000	200,000	500,000
60	●	●	●	—	—	—	—	—
120	●	●	●	●	—	—	—	—
240	—	●	●	●	●	—	—	—
450	—	—	—	●	●	●	—	—
1,000	—	—	—	—	●	●	●	—

Larger odorant storage options are available upon request.

Determination of the type of system and odorant vessel size for systems with interchangeable vessels

Interchangeable vessels	Maximum odorable gas flow [Nm ³ /h] with an odorant concentration of 20 µl/Nm ³							
Vessel sizes [liters]	10,000	12,500	20,000	30,000	70,000	100,000	200,000	500,000
25	OD7	OD7	—	—	—	—	—	—
50	OD7	OD7	OD7	—	—	—	—	—
100	—	OD7	OD7	OD7	—	—	—	—
200	—	—	OD8	OD8	OD8	—	—	—

Design of the LEWA diaphragm metering pumps for both system types

Max. permitted gas pressure	Maximum odorable gas flow [Nm ³ /h] with an odorant concentration of 20 µl/Nm ³							
[bar]	10,000	12,500	20,000	30,000	70,000	100,000	200,000	500,000
5	MAH/3	MAH/4	MAH/5	MAH/5	MBH/8	MLM 15/8	MLM 15/10	MLM 40/16
10	MAH/3	MAH/4	MAH/5	—	—	—	—	—
16	MAH/3	MAH/4	—	MBH/8	MBH/10	MLM 15/8	MLM 15/10	MLM 40/16
20	MAH/3	—	—	—	—	—	—	—
30	—	—	MBH/8	MBH/8	MBH/10	MLM 15/8	MLM 40/10	LDB 12
80	MLM 15/3	MLM 15/3	MLM 15/5	MLM 15/5	MLM 40/5	MLM 40/8	LDB 8	LDB 12
150	MLM 15/3	MLM 15/3	MLM 40/5	MLM 40/5	MLM 40/5	LDB 8	LDB 8	LDB 12
300	MLM 15/3	MLM 15/3	—	—	—	—	—	—

For gas flows which lie between the maximum values specified, the higher value must be taken into account in the design of the pumps and systems in each case.

Electronic control system technical data.

Odorizing control unit OCU, SPU, IOU, SIOU, EXU, ExOCU

Description	Modular controller for LEWA odorizing systems is a combination of different control cards, which are individually defined for each unit. They allow monitoring of pumps, flow meters and other system components.
Inputs	Digital (24 VDC/20 mA)/Analog (0/4-20 mA) max. load 120 ohms
Outputs	Digital (24 VDC/20 mA)/Analog (0/4-20 mA) max. load 600 ohms
Interfaces	RS232/RS485/MODBUS RTU additional interface via AnyBUS: - ProfiNetIO - MODBUS-TCP (Ethernet)
Power supply	230 VAC (via SPU230 card)/24 VDC (via SPU24 card)
Degree of protection	At wall housing EL 22xx: IP 55 to EN 60 529/09.2000
Permitted ambient temperature	-5 to +50 °C (with heating: -20 °C to +50 °C)

Technical data for Ex d and Ex e housing (ExOCU)

Explosion protection	II 2(1) G Ex d e [ia] IIC T4 Gb
Rated voltage	230 V 50 Hz
Degree of protection	IP66 (IEC/EN 60529)
Ambient temperature	+5 to +40 °C (with heating: -20 °C to +40 °C)
Housing material Ex d paint	Aluminum alloy EN AC-ALSi7Mg0.3 T6 uncoated

Individually programmed control system

In response to different customer requirements and project-specific conditions, LEWA odorizing systems can also be controlled by a programmable logic controller (PLC). LEWA offers a sophisticated and easily integrable hardware and software solution.

Electronic control system options:

Control of up to two metering pumps depending on operation mode:

- a) alternately, when only one pump should be in duty.
- b) common, when single pump can not handle the required flow.

Control of solenoid pumps or via frequency inverter for motor-driven pumps

Ability to monitor up to three gas meters with averaging and automatic change-over in the case of a failure of one of them

Simulation of a desired gas flow in the “internal” operating mode for service activities or in the event of a defective gas meter

Adjusting and monitoring a pre-selected odorant concentration in $\mu\text{l}/\text{Nm}^3$ or mg/Nm^3

Analog 0/4-20 mA output of the actual value of the concentration

Analog 0/4-20 mA input for external concentration target value

Coupling to a master computer via RS485 serial interface with the MODBUS RTU protocol

Connection via AnyBUS: ProfiNet-IO or MODBUS-TCP (Ethernet)

Ability to connect one or two gas chromatographs for detecting the odorant concentration(s) in order to adjust both odorant pre-concentration and desired odorant final concentration

Digital inputs for up to two pressure switches in order to monitor the diaphragm(s) of the metering pump(s)

Test programs for hardware tests and for checking the wiring

Filling logic for the coupling of a large container to the odorizing system’s storage tank with automatic storage tank filling

Connection of the LEWA odorizing control OCU



Creating Fluid Solutions. For more value created.



Technical consulting

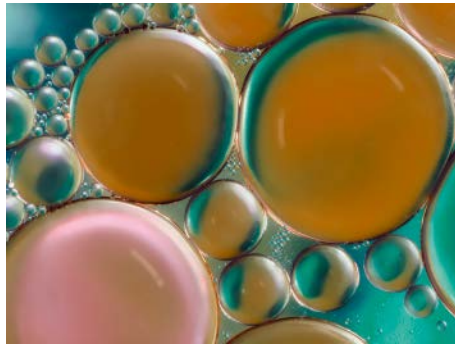

Fluid and process
engineering tests



Lifecycle concepts and
energy optimization

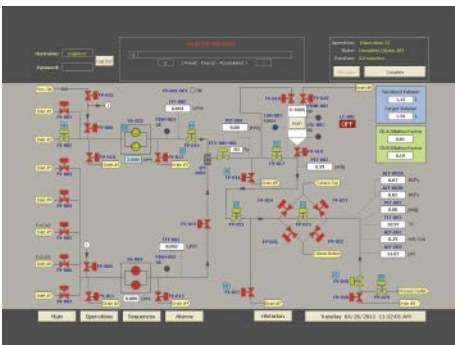

Process automation

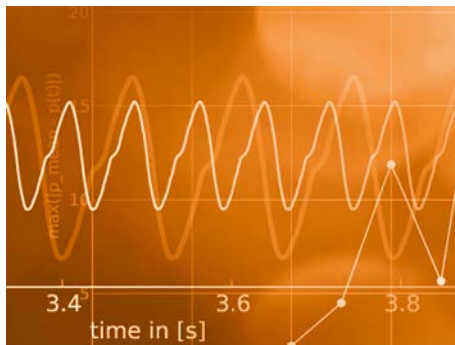

Pulsation studies and
pipeline calculations



System layout and integration



Creative development
and refinements

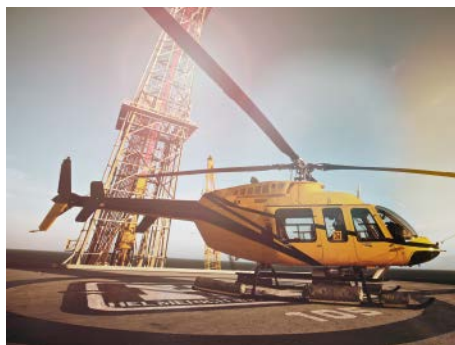

Commissioning and
maintenance service



Spare part and service concepts

Creating Fluid Solutions.

Driven by our commitment, our trendsetting products and innovative technologies have set benchmarks for diaphragm pumps and metering systems for over 70 years. We solve complex tasks from a single source. That ranges from custom pump design, basic and system engineering, global project management, and pretesting to commissioning and maintenance on site. Our consistent drive always to develop the best solutions for the customer provides you with a competitive advantage and visible added value.

Your local representative:

LEWA GmbH
Ulmer Str. 10
71229 Leonberg
Germany

www.lewa.com